

USER'S MANUAL

Digital thermostatic shower controller

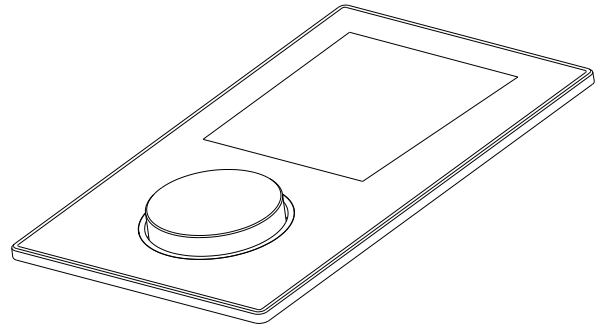

Please read this manual before using this product.

.system introduction & Structural drawing

Feature-----	1
Introduction-----	2
Structural drawing-----	3

Operation Instruction

Operation Instruction-----	4
Operation Instruction-----	5
Operation Instruction-----	6
Operation Instruction-----	7
Operation Instruction-----	8

Installation

how to install the battery into the host box-----	9
how to install Smart valve into the shower panel-----	10
how to install Smart valve into the shower panel-----	11
how to install Smart valve into the shower panel-----	12
how to install Smart valve recess into wall-----	13
how to install Smart valve recess into wall-----	14
how to install Smart valve recess into wall-----	15
how to install Smart valve recess into wall-----	16

Notice

Notice-----	17
-------------	----

Trouble shooting

Trouble shooting-----	18
-----------------------	----

Touch control panel

With touch control panel, easy to use.

Digital thermostat

Keep outlet water TEMP stable, the TEMP accuracy within $\pm 1^{\circ}\text{C}$.

Overheat protection

When the cold water cut off and lead the water TEMP over 49°C , system will stop water outlet in 2 seconds to protect user from hot water.

Water TEMP adjust

You can set the water TEMP as you like.

Water saving

You can adjust the water flow as you like, default working time is 18minutes, system will shut off as soon as time is up.

Prevent the water backflow

The hot and cold water inlets adopt the special design, can effectively to prevent the water backflow when the hot and cold water pressure difference.

Cold, hot water pressure difference

Our system can accept Max. 6:1 water pressure difference.

Double power supply, more safety and reliable

The voltage of our product is 12V. We provide an external adapter, which can transfer 100-240V to 12V power supply. When local power cut off, the system still work by battery inside host box.

Easy Installation

Recess mounted into the wall with wall bracket provided by us.

Thank you for choosing our Digital thermostatic shower controller!

Valve is a digital thermostatic shower controller. You can set the outlet water TEMP & water flow on touch panel as you like. Outlet water keep thermostatic TEMP. Complete set including the control panel, host box and adapter.

- ① hand shower
- ② head shower
- ③ water outlet pipe of hand shower
- ④ water outlet pipe of head shower
- ⑤ AC220V plug seat
- ⑥ Power adapter
- ⑦ Power supply cable of the host box
- ⑧ Host box
- ⑨ Battery cover
- ⑩ Control cable of the host box
- ⑪ Hot water inlet
- ⑫ Cold water inlet
- ⑬ Cold water switch
- ⑭ Hot water switch from water heater
- ⑮ Control panel
- ⑯ Control panel's control cable

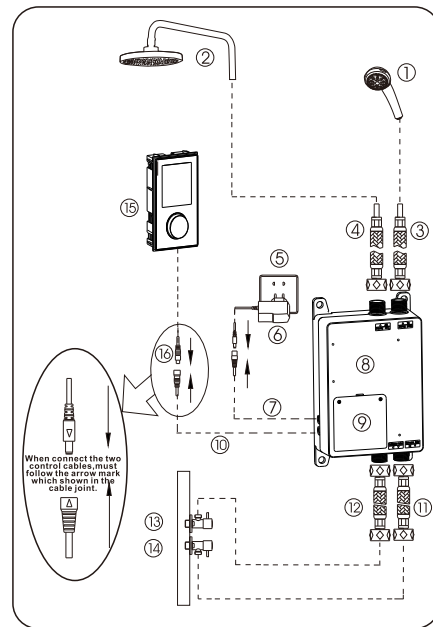

Structural drawing of host box

The host box of Valve , has hot water inlet, cold water inlet, water outlet to the hand shower & the head shower, the control cable , power supply cable, battery cover and the bracket.

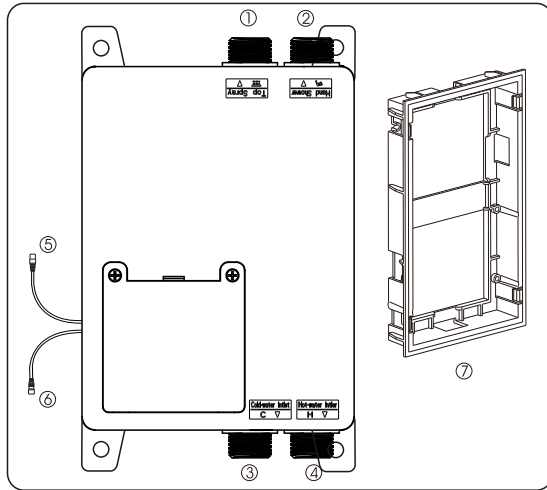

host box dimension:131x181x65mm

- ① Hand shower's mixer water outlet
- ② Head shower's mixer water outlet
- ③ Cold water inlet
- ④ Hot water inlet
- ⑤ the control cable
- ⑥ the control cable
- ⑦ bracket

Operation



- ① Fly-shuttle switch
- ② Setting button
- ③ Spray button
- ④ LCD display

Notice

- 1、 The control panel is sensitive, when install it, please avoid to let it ace directly to the water from hand shower and the head shower, because water will get it mis-operation or lock the control panel.
- 2、 The touch button is the best sensitive area.
- 3、 The touch panel has water splash protection technology. When system detect mis-operation, no response and need about 1 second to recover.

Function

- 1、 Water TEMP adjust
- 2、 Hand shower
- 3、 Head shower
- 4、 Water flow adjust

Operation

1 Power on/off

Power on

A. After electrify (The battery without electricity or not install battery), press the fly-shuttle switch, power on and switch on the head shower automatically, adjust the thermostatic Temp function. When you hear buzzer sound, the fly-shuttle switch and LCD display would be lighting.

B. After electrify (The battery with electricity), press the fly-shuttle switch in 20 minutes from last time turn it off. When power on, open the last time spray mode and TEMP adjustable function (cold water or thermostatic function); if press the fly-shuttle switch from more than 20 minutes from last time turn it off, power on and open the head spray and TEMP adjustable function at the same time. You could hear buzzer sound, the fly-shuttle switch and LCD display would be lighting.

C. When system on, Water TEMP and water flow will be same as that you set last time. Head shower (or hand shower) shows cursor and icon.

D. If you didn't set working time, default working time is 60 minutes.

Power off



A. When system on, press the fly-shuttle switch to power off system, you can hear buzzer sound.

B. System will switch off automatically when working time comes up.



Hand shower and head shower switch

When system on, pressing  button on the panel to switch the water outlet way between head shower and hand shower. When cursor and frame move to the head shower icon, head shower comes water. When cursor and frame move to the hand shower icon, hand shower comes water.



Setting

When system is on, rotating the fly-shuttle switch to adjust the water flow, press the  button to adjust water TEMP and water flow. Press  button and keep for 3 seconds to set working time. System will restore to adjust water flow if no press any button for 5 seconds.

Water TEMP adjust and cold water mode

When system on, touch button  to enter into TEMP adjusting, cursor and frame will move to TEMP icon . The  icon on the LCD panel flash, at this time you could set water TEMP from 29-48°C. Rotate the fly-shuttle to adjust water TEMP and you can hear buzzer sound for each step.

When the TEMP is lowest, rotating the fly-shuttle switch one round counter-clockwise to enter into cold water mode, cursor and frame will move to the cold water icon. You can hear buzzer sound when system enter into cold water mode. If you rotating the fly-shuttle switch one round clockwise, system will enter into the water TEMP adjusting again.



If no any touch on the panel for 5 seconds, water TEMP will be memory and exit the water TEMP adjusting. Touch  button again to enter into water flow adjusting.  icon on the LCD panel will stop flashing. The fly-shuttle switch backlight color will change according to the water TEMP as below: blue color: water TEMP ≤ 33°C; blue; orange color: water TEMP < 41°C; red color: ≥ 41°C.

Setting system on time

When system on, touch panel  switch to system on setting, show **Time_x** icon. Rotating the fly-shuttle to setting system on time, counterclockwise rotation is to reduce and clockwise rotation is to increase, setting range is 15-60 minute. You can hear buzzer sound for each adjustment.

Stop setting for 5 seconds or touch button , system on setting time TEMP will be memory and exit system on time setting, switch to water flow setting, close **Time_x** icon.

Water flow

When system on, rotating the fly-shuttle switch to adjust water flow by default, if system on other setting state, touching button  can switch to water flow setting. Cursor and frame will move to the water flow icon ,  icon on LCD panel flash, setting range is 4-18L. Rotating the fly-shuttle switch to adjust water flow, counter-clockwise rotating is to reduce flow and clockwise rotating is to increase flow. You can hear buzzer sound for each adjustment. When water flow reach the lowest and highest, no buzzer sound.

No touch any button for 5 seconds, water flow value will be save. Or when you touch button , water flow value will be save and switch to TEMP adjusting.

Working time setting

When system on, keep pressing button  for 3seconds, system will enter into the working time setting, icon Time will be shown on the LCD panel. Rotating the fly-shuttle switch to adjust the working time. Time range is 15-60minutes. You can hear buzzer sound for each adjusting.

No touch any button for 5 seconds or press button , working time value will be save and switch to TEMP adjusting.

Count down display

When system on, the LCD panel shows count down for 60minutes if head shower or hand shower is open.

Abnormal alarm

When water TEMP is over 49Celsius degree, system will stop working and no water outlet automatically. You could hear 3 times of buzzer sound. And the LCD panel shows error code “EE”.

Back up battery

- 1) When system working based on battery, LCD panel shows the current battery status. When system working by the local power supply, and battery is not full, LCD panel shows charging status, until the battery is full.
- 2) When system working based on battery, the back-light of fly-shuttle button and LCD panel would become dark to save energy.
- 3) When system working based on battery and battery almost use out, if system is in working state, system will shut off automatically.

Working condition

Voltage rating	AC110-220 V	Frequency rating	50/60Hz	Power rating	6W
Insulation Resistance	>20MΩ	Waterproof rating	IPX5		

Load parameter

Load category	Rated load voltage	Rated load frequency	Rated load power	Other
Switch valve	DC12V	————	2W	————
Flow valve	DC5V	————	1W	————
Thermostatic valve	DC12V	————	2W	————

There are two kinds of installation ways for Valve shower controller according to the installation site, one way is to recess mount into the wall. Another way is to build into the shower panel.

A. Battery Installation

1. Loose the screws on the battery cover and take it off.

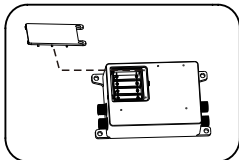

2. Putting 4pcs rechargeable batteries into the battery slot of host box.

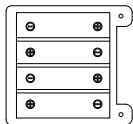
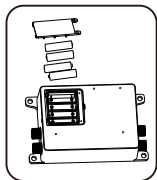

Attention:

When putting the battery into the host box, you need to identify the anode and the cathode.

3. Insert the battery cover into the host box, and lock it with the screws.

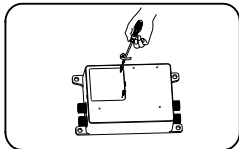

Caution:

- Using rechargeable NI-MH battery [the 5#(AA) and the capacity is more than 1000Mah].
- After electrify, forbid using the normal 5#(AA) battery. Otherwise, would cause the battery explosion.
- When the power cut, you can use the high quality normal 5#(AA) dry battery as the emergency measure. But you must unplug the adapter.
- When you install the host box, please put the battery into it. If the product haven't connected with the power in a long time. Please take out the battery from the host box. This way can avoid affect the battery working life.
- If you want to the battery with a longer working life, you can charge the battery every some months.

Installation of the control panel

1. Build the control panel into the shower panel

Step 1 Open an hole (170mm X 95mm) on the shower panel, putting some glass cement around the back of the control panel and fit it on the hole of the shower panel as picture shown.

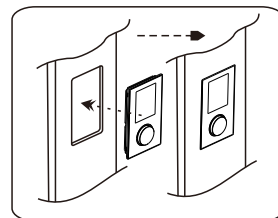
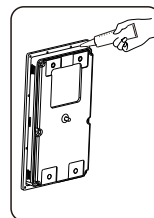
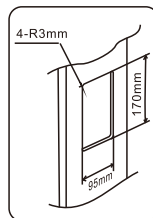

Installation of the control panel

Step 2 Fasten the mounting bracket onto the back of the control panel by screws.

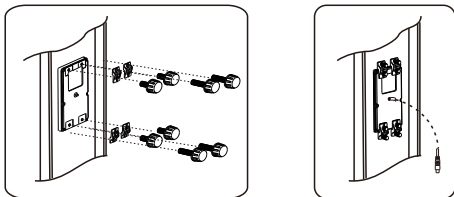

Step 3 Install the host box on the back of the shower panel, connect the cold water and hot water pipe, hand shower and head shower's pipes.

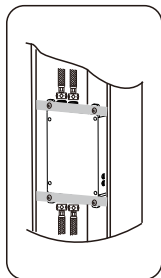

1. Connect the G1/2" hot and cold water inlet pipes to the host box, tighten it and make sure connection is well sealed (as the picture showed).
2. Connect the G1/2" water inlet pipe of the faucet to the water outlet pipe of the host box, tighten it and make sure connection is well sealed (as the picture shown).

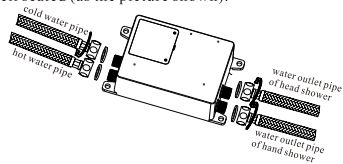

Caution:

- When installation, the hot water pipe and the cold water pipe can not mix up. Otherwise, the system can not work.
- When you tighten the connector nut, torque should not exceed 8NM, GB 2.5NM is OK, otherwise, it will damage the connector of the mixing valve and lead to water leaking.

Installation of the control panel

Step 4 Connect the host box control cable with the control cable of shower faucet as arrow mark as picture.

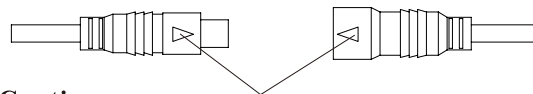

Caution:

When connect the two control cables, must follow the arrow mark which shown in the cable joint. If not, will damage the cable joint.

Step 5 Connect the power supply cable of the host box with the adapter.



1.Recess mounted into wall

According to the wall thickness, you can choose installation method A or B.

Method A : If the wall is thin, the host box and the shower control panel can be installed in different position.

Method B : If the wall is thick, the host box and the shower control panel can be installed in the same position.

Installation step of method A :

Step 1 open two hole in the wall, and reserve space for the pipes and adapter.

Step 2 Drill four holes by 6mm diameter on the upside hole for install the wall bracket (as the picture) and put the plastic screw into the hole.

Step 3 Drill four holes by 8mm diameter on the downside hole for the host box installation and put the expansion screws into the hole.

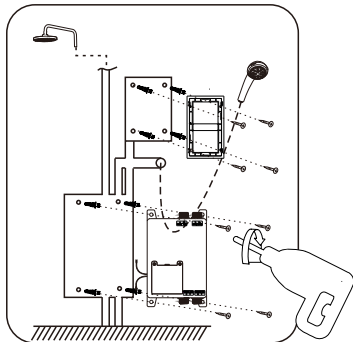
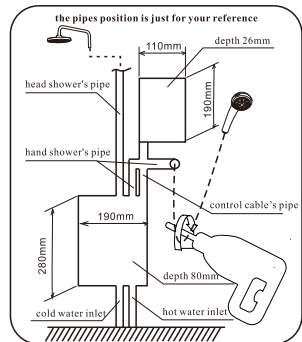

Step 4 Install the wall bracket of control panel and the host box in two holes, according to the pipe's position to set the host box position, adjust the screw of wall bracket to make sure it is concave the wall surface with 0.5-1mm difference.

Step 5 Connect the water pipe and the power supply cable of the host box, get water supply to make sure the pipe no leak. Connect the host box control cable to the control panel hole and fasten it, using the cement to seal the wall and cover by the tiles.

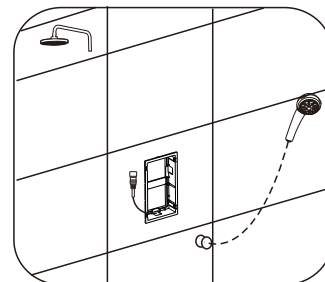
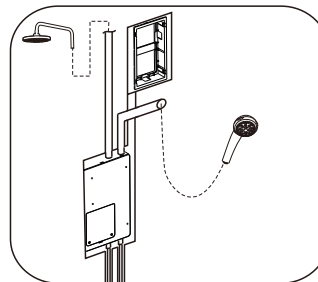

Step 6 Connect the control cable between the host box and the control panel, putting some silicon on the back case of the control panel and put it on the wall bracket.

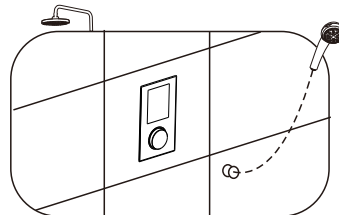
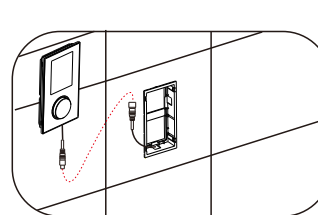

Installation of the control panel

Method B : if the wall is thin

Step 1 Open one hole in the wall, and reserve space for the water pipes and power supply cable.

Step 2 Drill four screw holes by 8mm diameter in the hole for the host box installation and put the plastic screw into the holes.

Step 3 Fasten the control panel's bracket onto the host box by the M3 Self-tapping screws provided. Install the host box which with the bracket into the hole by the plastic screw. (according to the the pipe's position to set the host box position), adjust the screw to make sure the bracket's surface is lower than the wall surface with 0.5-1mm.

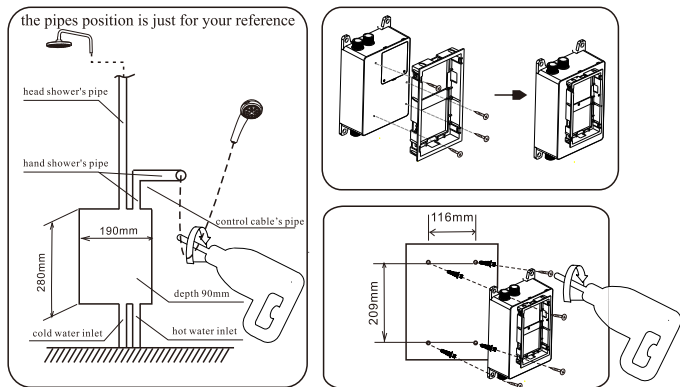

Installation of the control panel

Step 4 Connect the water pipe and the power supply cable of the host box, get water supply to test the pipe no leak. Lead the host box control cable out to the control panel's bracket and temporary fasten it. And then use the cement to seal the wall and cover by the tiles.

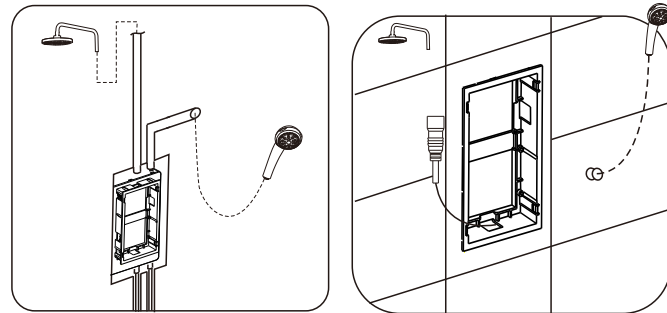

Step 5 Connect the control cable between the host box and the control panel, putting some silicon on the back case of the control panel and put it on the wall bracket.

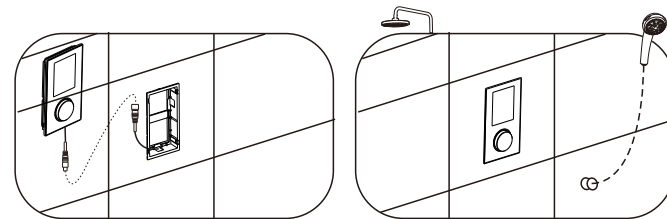

Notice

- Working water pressure is 0.05MPA-0.6MPA.
Please install a water pressure release valve if water pressure more than 0.6MPA.
- Our shower controller don't have heater function, it should be using with water heater. Max. water TEMP accepted is 85℃. If not necessary, we suggest you to adjust the water outlet TEMP from the heater to be 65℃ lower.

Caution:

- If working with the electric instant water heater or the gas water heater, hot water TEMP from heater can not set higher than 5℃ than the preset water TEMP on the panel.
- After electrify, the system can charge the rechargeable NI-MH 5#(AA) battery automatically. The rechargeable NI-MH 5#(AA) battery would use out after long time delivery, please put the battery as instruction and charge it after electrify the system.

- To be safe, please touch water TEMP by your hand to make sure ok before bath.
- Forbid to use the normal 5#(AA) dry battery. Otherwise, it will cause the battery explosion.

Trouble shooting

Problem	Possible Reasons	Solution
Water flow low	setted water flow too low	set higher water flow
	low water pressure	check the water supply
	the faucet outlet use the water flow limit design	needn't to solve
Outlet water TEMP is lower than the display TEMP	water outlet pipe is too long, lead the TEMP cold down	shorter the pipe between the mixer and the shower faucet
	the TEMP haven't been adjusted steady	please wait the TEMP adjust steady
	set the water flow too low	needn't to solve
	Water TEMP from heater is cold	Increase water TEMP from heater
Outlet water TEMP is higher than the display TEMP	malfunction on host box	please contact the factory
	the TEMP haven't been adjusted steady	please wait the TEMP adjust steady
	the running water TEMP is higher than the setting TEMP	needn't to solve
Response time of TEMP adjust is slow	malfunction on host box	please contact the factory
	Low water flow	needn't to solve
	long time not use the hot water, cold down in the pipe and the hot water pipe is too long	shorter the pipe distance between the heater and the faucet and so you can drain the cold water in pipe quickly
Overheat alarm	malfunction on host box	please contact the factory
	no cold water supply	check the cold water supply pipe, fix problem before turn on shower faucet
The touch button not sensitive	too much water on touch panel	clean the water
Outlet water TEMP is not stable when H202A work with instant water heater, gas heater or the centralized heating system because heater not work always	The electric instant water heater and the gas water heater's can not work if water flow low than it's default value	1.For gas heater or instant heater, it won't work for low water pressure. Set almost same water TEMP of gas heater and instant heater as that setted on H202A. 2.Increase the water flow of H202A.